

If applicable, what type of secondary heating unit do you use?

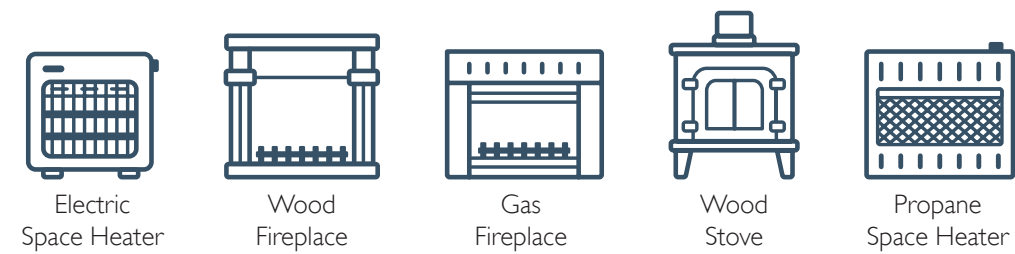

How many hours per year do you utilize your secondary heating unit?

What type of foundation does your home have?

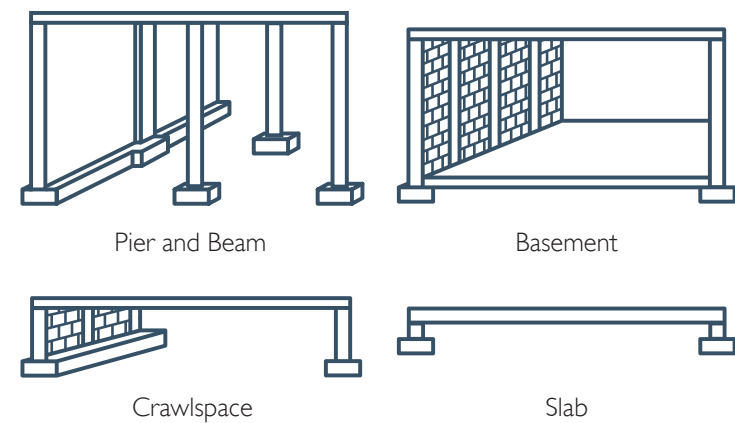

If applicable, what type of insulation does your basement or crawlspace have?

- Ceiling
- Wall
- Ceiling and Wall
- No insulation
- Don't know

What type of air conditioning (AC) system does your home have?

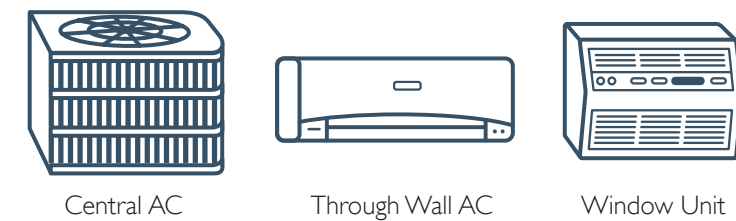

Are your AC unit(s) ENERGY STAR® certified?

- Yes
- No
- Don't know
- Don't have one

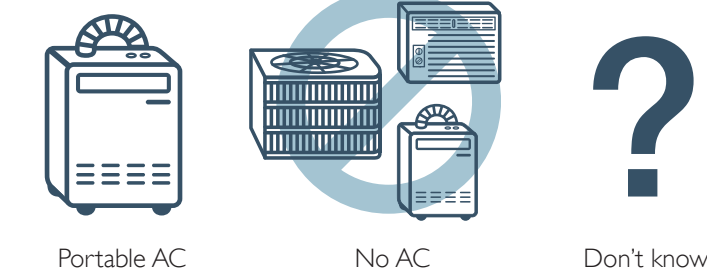
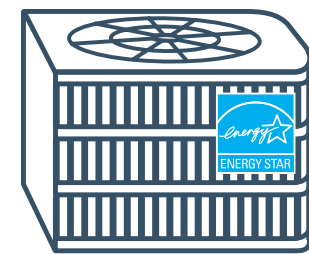

Is your pool pump ENERGY STAR® certified?

- Yes
- No
- Don't know
- Don't have one

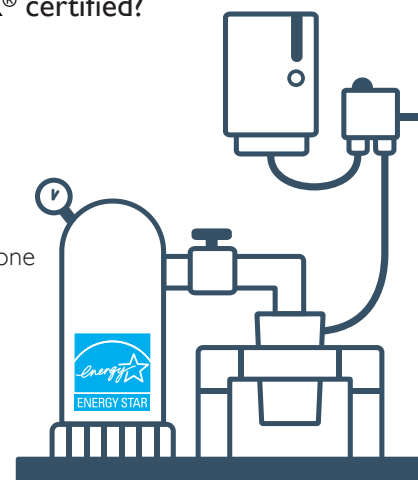

If applicable, how old is your AC system?

- 0–5 years
- 6–10 years
- 11–15 years
- 16+ years
- Don't know

## About You

Please provide your information for a personalized report.

First Name  Last Name

Address Line 1

Address Line 2

City  State  Zip Code

Phone Number  Email (optional)

Local Power Company  How did you hear about eScore Self Audit program?

Mailing Address, if different from above

City  State  Zip Code

## About Your Home

Total Square Footage of Home  Total Number of Occupants  Total Number of Bedrooms

What type of home do you have?

- Apartment
- Single Family
- Manufactured Home
- Townhome
- Condo
- Other

Do you own or rent your home?

- Own
- Rent

How long have you lived in your home?

- 0–2 years
- 3–5 years
- 6–10 years
- 11+ years

How old is your home?

- 0–5 years
- 6–10 years
- 11–20 years
- 21+ years

Do you have Wi-Fi in your home?

- Yes
- No
- Don't know

## eScore™ Self Audit



Take an eScore Self Audit to improve your home's energy efficiency and learn how to save money and live comfortably. Simply fill in or circle the answers that best describe your home. When you are finished, mail it back in the provided envelope to receive your personalized report.

**Instructions**  
For each question, use a dark pen to fill in the circle next to your answer, or clearly circle the picture most like your home.



What type of roof do you have?

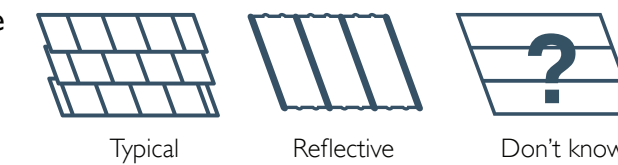

Is your home drafty?

- No
- Somewhat
- Very much
- Don't know



Where are the ducts located in your home?

Tip: If you have multiple duct systems, please select the location of the largest system.

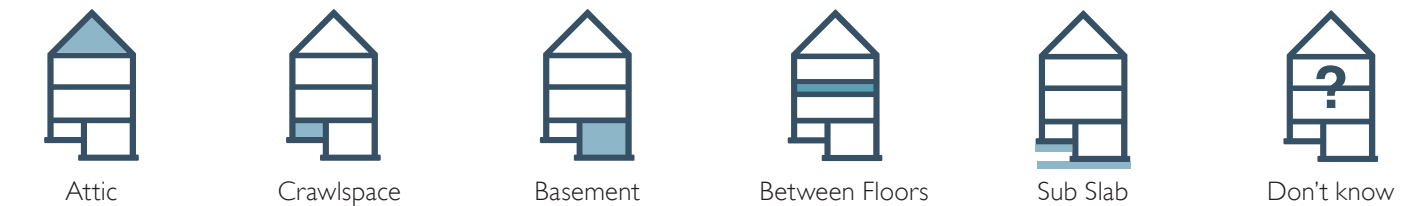

What is the condition of your ducts?

- Excellent
- Good
- Poor
- Don't know

Is your attic insulated?

- No insulation
- A little insulation
- A lot of insulation
- Don't know

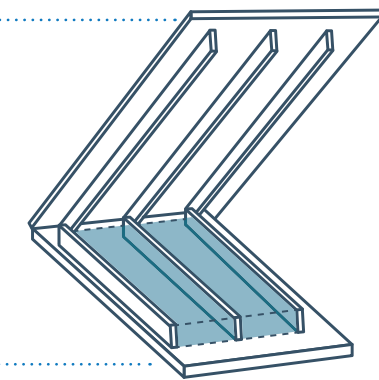

Are your TV(s) ENERGY STAR® certified?

- None
- Some
- All
- Don't know



Do you have a programmable thermostat?

- Yes
- No
- Don't know



Please enter heating and cooling settings on your thermostat.

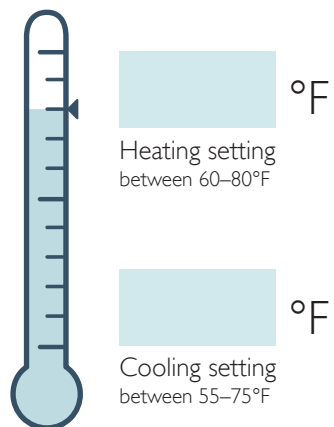

Are your exterior walls insulated?

- Yes
- No
- Don't know

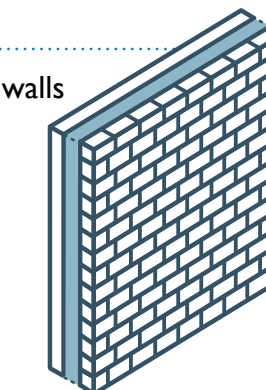

Does your front door have weather stripping?

- Yes No Don't know

If applicable, what is the condition of the weather stripping?

- Excellent Poor Good Don't know

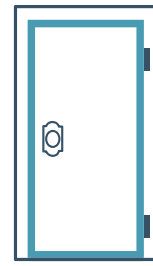

Is your front door solid or hollow core?

- Solid Core Hollow Don't know

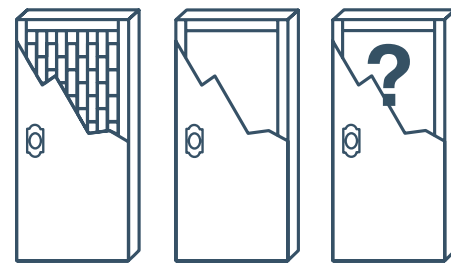

What type of front door does your home have?

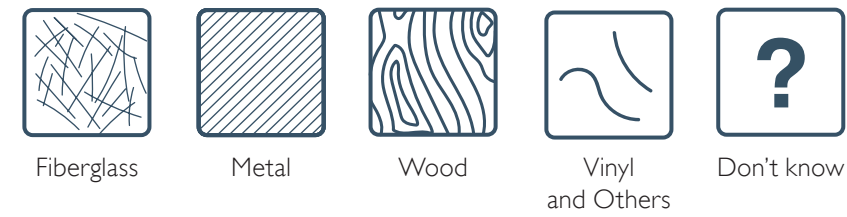

Is your door ENERGY STAR certified?

- Yes No Don't know

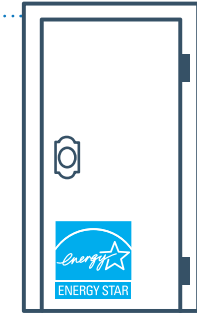

Do you have a kitchen faucet aerator?

- Yes No Don't know

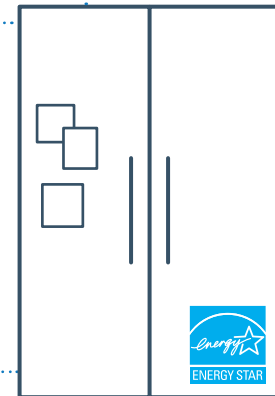
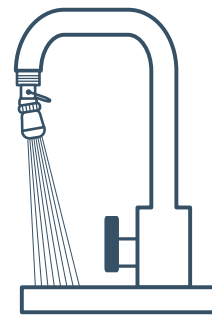

Is your main refrigerator ENERGY STAR certified?

- Yes No Don't know

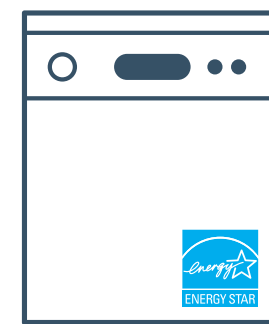

Is your dishwasher ENERGY STAR certified?

- Yes No Don't know Don't have one

How old is your main refrigerator?

- 0-5 years 6-10 years 11-15 years 16+ years Don't know

Do you have a second refrigerator or freezer?

- Yes No

Is it ENERGY STAR certified?

- Yes No Don't know

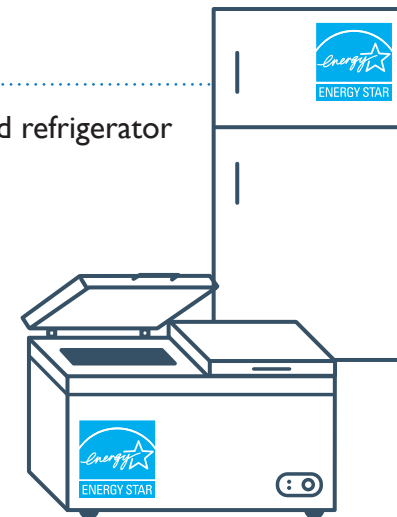

What % of each light bulb do you use in your home?

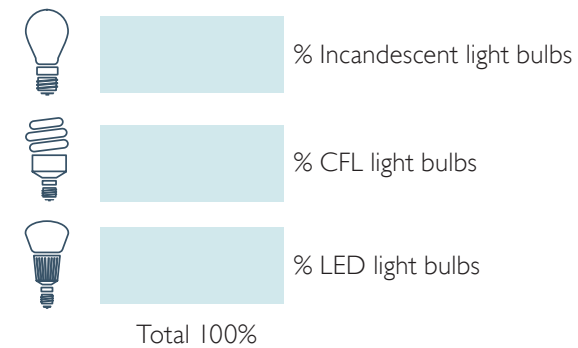

Is it ENERGY STAR certified?

- Yes No Don't know

What is the most common type of window in your home?

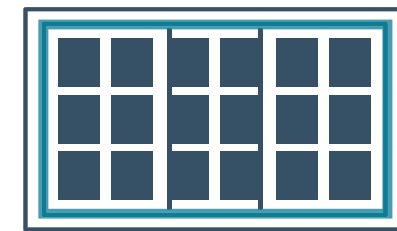
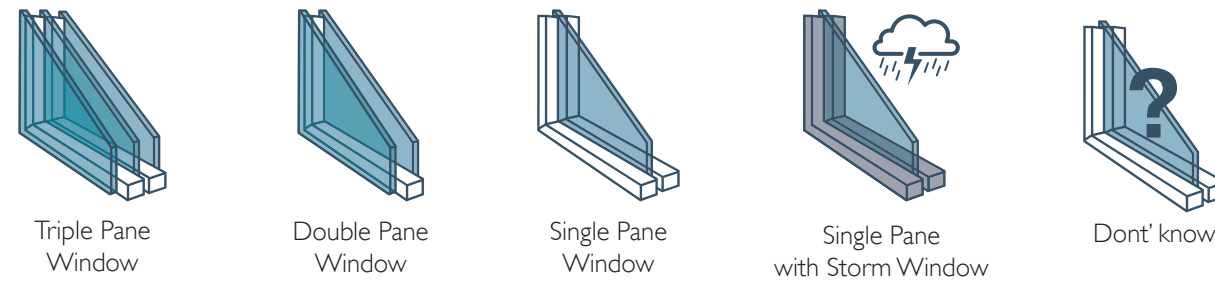

Are your windows ENERGY STAR certified?

- Yes No Don't know

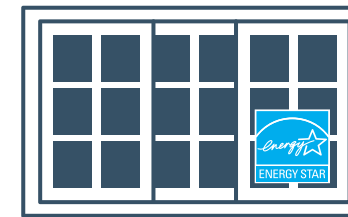

In what condition are your windows?

- Excellent Poor Good Don't know

Do you have low-flow toilets?

- Yes No Don't know

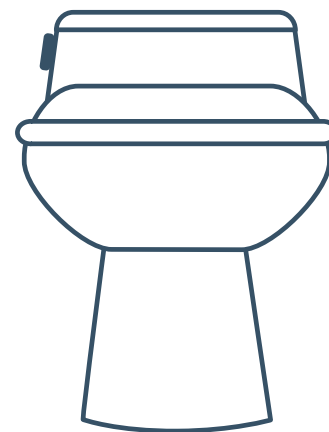

Do you have low-flow showerheads?

- Yes No Don't know

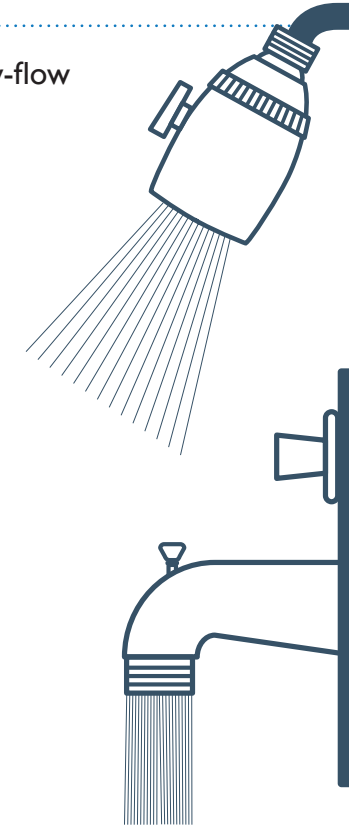

Do you have bathroom faucet aerators?

- Yes No Don't know

Are your computer(s) ENERGY STAR certified?

- None Some All Don't know



Is your clothes washer ENERGY STAR certified?

- Yes No Don't know Don't have one

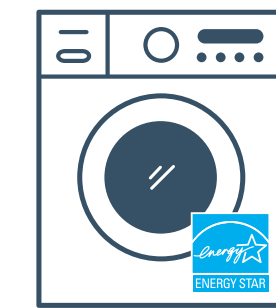

What type of water heater does your home have?

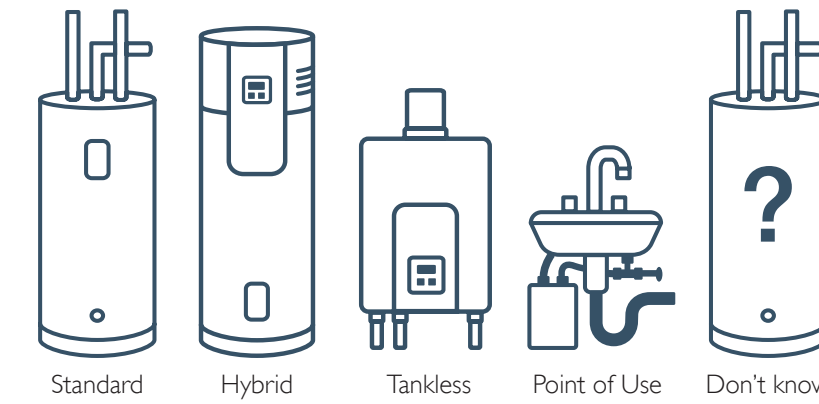

What is the fuel source for you water heater(s)?



What type of primary heating system does your home have?

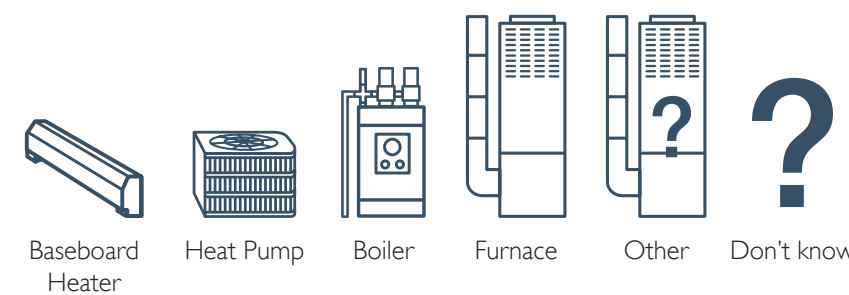

How old is your primary heating system?

- 0-5 years 6-10 years 11-15 years 16+ years Don't know

What is the fuel source for your primary heating system?

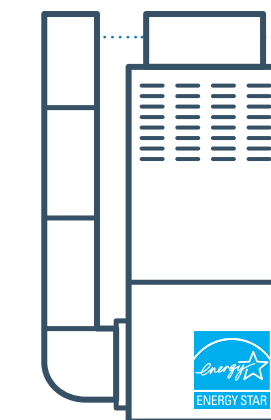

Is your primary heating system ENERGY STAR certified?

- Yes No Don't know

Do you use a secondary heating unit?

- Yes No Don't know

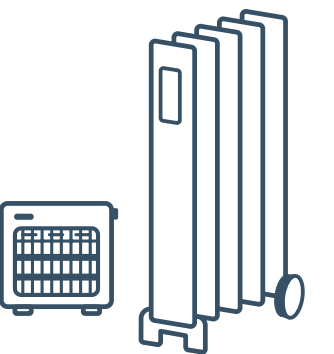

Is your water heater wrapped with an insulating blanket or jacket?

- Yes No Don't know Not applicable

How old is your water heater?

- 0-5 years 6-10 years 11-15 years 16+ years Don't know

Is your water heater ENERGY STAR certified?

- Yes No Don't know

